

WSTII (I、III) 5系列无励磁条形分接开关

WST-Series of No-load Strip Tapping Switches

使用说明书

Operation Instruction

厂家提醒您注意阅读
Which manufacturer reminds
you to read carefully

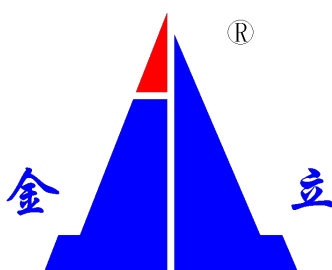

IS09001: 2000认证企业

辽宁金立电力电器有限公司
Liaoning Jin Li Electric Power
Equipment Co., Ltd.

1. 产品用途及使用范围 Application and operating scope

本系列分接开关采用了新结构、新材料、新工艺，具有结构合理、手感好、转动灵活、到位准确等优点。。适用于频率50、60Hz，额定电压10KV、、35KV，额定电流400A~600A油浸式电力变压器。可直接固定在变压器箱盖上，在变压器无励磁状态下改变变压器初级线圈的匝数，从而改变变压器电压的变化，达到调整次级输出电压的目的。

This series of no load switch adopted a new structure, new materials, new technology, the structure is reasonable, feel is good, flexible rotation and in place accurate, etc. Apply to frequency 50, 60 Hz, rated voltage 10 KV, 35 KV and rated current 400 A ~ 600 A oil-immersed power transformer. Can be directly fixed in box cover of the transformer ,under the condition of non-excitation of the primary winding transformer circle number, which changes transformer voltage change, to adjust the subprime output voltage purpose.

2. 型号说明 Explanation of Types

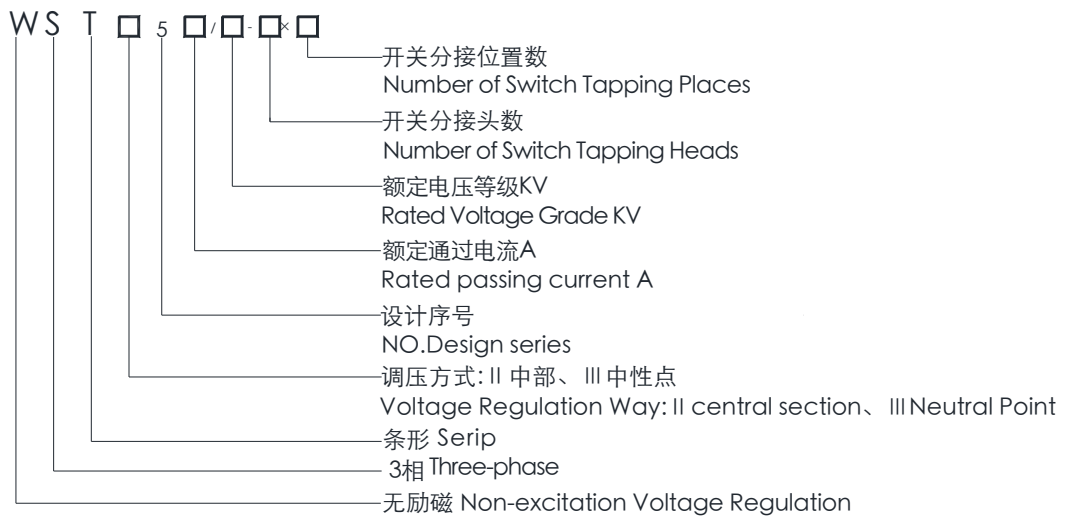

3.主要技术参数Major Technical Parameter

规格specification		WST400	WST 500
相数 number of phase		三相 three phase	
连接方式 connect way		中部调压 (II)、中性点调压	
最大额定通过电流 (A the rated current)		400A	500A
短路试验电流 (KA) test current in short circuit	热稳定 (3s) Thermal stability	6	9.45
	动稳定 (峰值) Dynamic stability	15	23.6
额定频率 (Hz) rated frequency		50~60	
最大工作位置数 The maximum working position number		5	
额定绝缘水平 (KV) Rated insulation level	设备最高电压UmEquipment highest voltage	12	40.5
	额定工频耐受电压 (50Hz/1min) Rated power frequency voltage tolerance	42	95
	额定冲击耐受电压 (1.2/50μs) The rated voltage impact resistance	75	200
工作压力 (Kpa) working pressure	60		
机械寿命 (千次) Mechanical life (Thousands times)	2		

4.工作原理The principle of operation

通过手柄往返旋转带动齿条机构运动，齿条带动动触头水平移动，以改变开关的分接位置，从而改变变压器初级线圈的匝数，达到改变变压器的变化，调整次级电压的目的。

Driven through the handle from rotating rack body movement, led moving contacts horizontal rack to change the tap position of the switch, thereby changing the transformer primary winding turns, to change the transformer changes, adjust the secondary voltage of purpose.

5.使用注意事项Caution for operation

5.1适用于变压器频率为50Hz~60Hz。

5.2使用环境温度：空气中-25°C~40°C，油中-25°C~100°C。

5.3安装场所应无爆炸与腐蚀性气体。

5.4分接开关组装前，一定要检查分接开关是否符合变压器型号要求，以免造成不

应有的损失。

5.5 变压器分接抽头引线不能过短，以免造成开关的绝缘杆变形导致操作力矩过大和触头接触不良。

5.6 分接开关在安装使用前放在 $105^{\circ}\text{C}\pm 5^{\circ}\text{C}$ 烘箱中或与变压器器身一起干燥24~48小时进行去潮，干燥后如分接开关沿转轴渗油，请将塞子旋紧即可，如沿变压器箱盖渗油，请将圆螺母旋紧即可。见图2

5.7 当开关在极限档位时，严禁向极限方向用力扳动手柄。

5.8 开关在完成调换后，应将定位螺钉旋入法兰档位定位孔内，以防止变压器在运行中开关触头接触窜动而将变压器烧毁，防护罩是防雨装置，故一定要拧紧，切勿丢失。

5.9 分接开关干燥后，必须将静触头与动触头滴上变压器油后方可旋转开关，组装前应将分接开关来回旋转5~8次。

5.1 Apply to frequency of transformer 50 Hz ~ 60 Hz

5.2 Use of environmental temperature: in air $-25^{\circ}\text{C} \sim 40^{\circ}\text{C}$, in oil $-25^{\circ}\text{C} \sim 100^{\circ}\text{C}$.

5.3 Installation places should not be explosive and corrosive gases.

5.4 Before tap-assembled, be sure to check whether the tapping switch could meet the transformer type requirements, so as to avoid unnecessary losses.

5.5 Transformer tap-tap-lead can not be too short, and eliminate the lead tension in the assemble so as to avoid switching operation of the insulating rod deformation lead to poor contact and torque too large.

5.6 Tap should be on the $105^{\circ}\text{C} \pm 5^{\circ}\text{C}$ oven or dry transformers with the body of 24 to 48 hours to the influx of dry tap before installed and use, such as oil leakage along the shaft, tighten the stopper, if the oil leaks along the transformer lid, tighten the round nut.

5.7 When the switch unit is in the limit is strictly prohibited forced to slid the handle to the direction of limit.

5.8 After The switch complete exchanging, should will locate the batter screw flange gear hole position, in order to prevent the transformer in operation of switch contacts there and will contact dynamic transformer burned up, and the cover is rainproof device, so have to be tightened, not lost.

5.9 Tap-dried, must drop the transformer oil on static contact and moving contacts then rotary switches. rotate back and forth the tap 5~8times before as

6. 安装程序 Installation procedure

如图2: 旋下防护罩，旋下圆螺母，将以上零件放到一起，不要丢失。然后将带有“O”型密封圈的开关从箱盖下面向上伸出，用圆螺母将开关固定在变压器箱盖上，并将开关尾端支板与变压器的焊块用螺栓固定住，注意一定要保证开关的本体与箱盖平行以保证主传动部分的齿轮齿条正确啮合。

Unscrew the shields, unscrew the round nut, put above parts together, don't lost. Then will have "O" type of sealing ring from the box cover up switch out below, with round nut will switch fixed in transformer the box cover, and will switch end plate with the welding piece with transformer with bolt lived, more attention to ensure that the ontology and switch box cover parallel to ensure the main transmission part of the super-modulus gear meshing correctly.

7. 维护 Maintain

操作必须在变压器完全从电网上切除，在变压器无励磁的情况下进行。

7.1 如图2: 旋下防护罩，旋出定位螺钉，伸直手柄，往返旋转手柄3~5个循环，然后将手柄旋到需要的分接位置上，再左右微动手柄几次，将定位螺钉旋入法兰档位定位孔内，再将上述各件复原，有条件的最好对其接触情况测量，以验证其接触可靠性。

7.2 开关在正常运行时，为了防止锈蚀保证转动的灵活性，每两年至少进行一次维护。方法同7.1。

7.3 一般故障维护方法

当箱盖密封出现渗油现象时，应调节圆螺母松紧，失效时应及时更换“O”型密封圈。当开关轴上出现渗漏油时扭紧调节塞子。

Operation of the transformer must be removed completely from the electricity grid, in the transformer without excitation of the circumstances.

7.1 Unscrew the shields, spin out positioning screws, unbend the handle, rotates back and forth from three to five circulation, and then put the handle to the need of the lead screw position, to handle the control again several times, will locate the batter screw flange gear hole position, then recovery the above all, had better test contact measurement to verify its contact reliability

7.2 When the switch in normal operation, in order to prevent corrosion to ensure the flexibility of rotation, maintain less than once every two years. Approach with method 5.1.

7.3 General maintenance methods

When the lid seal oil leakage phenomenon occurs that there should be regulation round nut, elastic, failure should be timely replace the O type seal ring. When the switch leakage of oil occurs on the switch axis should tighten the regulation stopper.

8. 贮存、运输 Storage、transportation

8.1 存放在空气流通，阴凉，干燥，无腐蚀性气体的环境中。

8.2 在运输途中应小心轻放，严禁冲击，防水防潮。

8.1 Deposited in the air circulation, cool, dry, non-corrosive gas environment.

8.2 In transit should be handled be care, non-impact, waterproof and anti-moisture.

9. 订货须知 notes to order

9.1 指明产品型号，名称，数量及交货日期。

9.2 有特殊要求的应提供额定电压，额定电流，分接级数及级间电压，或提供变压器接线原理图，技术参数及安装尺寸。

9.1 Specify the product model, name, quantity and delivery date

9.2 With special requirements should provide the rated voltage and rated current, the lead series and between voltage level, or provide transformer wiring diagram, technical parameters and installation size

10. 安装尺寸图 the drawing of install dimension

10.1 中部调压条型分接开关外形、安装尺寸图

Outline Diagram and Mounting Dimension List of the Central Voltage Regulating Strip tap changer

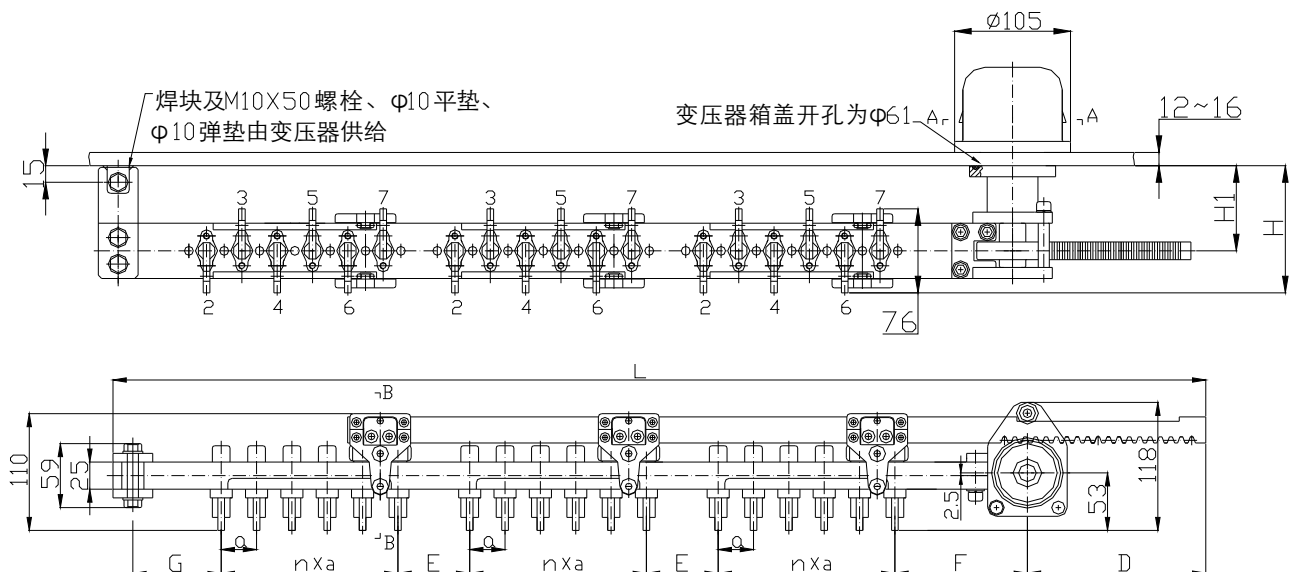

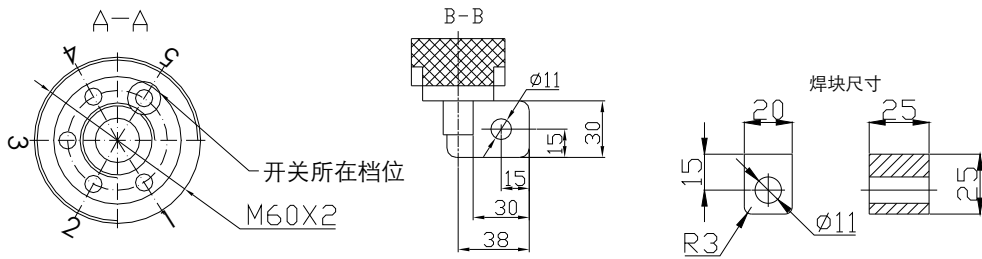

产品型号 Product Type	安装尺寸 (mm) Mounting Dimension								
	L	E	F	G	a	n	D	H	H1
WSTII5 400~500/10-4×3	746	65	120	80	32	3	110	115	78
WSTII5 400~500/10-6×5	990	65	120	80	32	5	162	115	78
WSTII5 400/20-6×5	1191	80	155	100	38	5	188	156	118
WSTII5 400~500/35-4×3	987	120	170	100	38	3	117	156	118
WSTII5400~500/35-6×5	1286	120	170	100	38	5	188	156	118

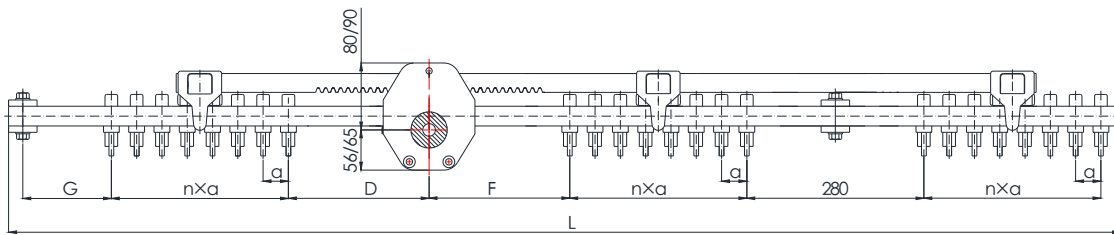
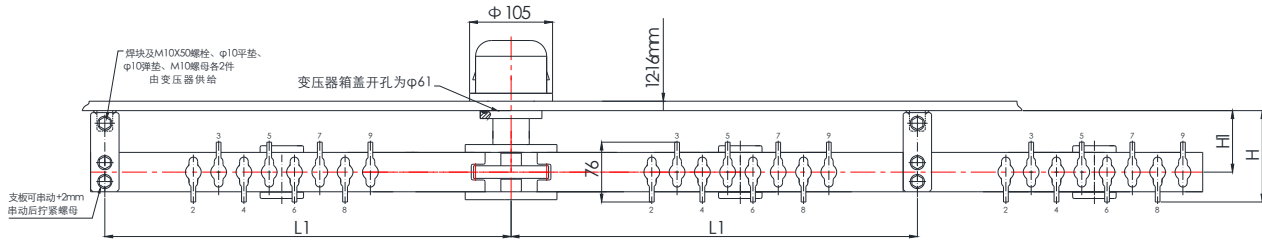

接线片尺寸
Size of connection terminal
2:1

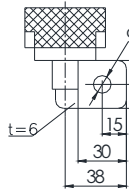

焊块尺寸
Size of welding unit
2:1

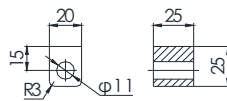

开关型号 Model No.	安装尺寸 (mm) Install Dimension								
	L	L1	F	D	G	n	a	H	H1
WST II 5 400~500/10-8×7T	1195	424	120	120	80	7	32	115	78
WST II 5 400~500/35-8×7T	1634	594	188	188	140	7	38	156	118
WST II 5 400~500/10-10×9T	1387	488	120	120	80	9	32	115	78
WST II 5 400~500/35-10×9T	1862	670	188	188	140	9	38	156	118

10.2中性点调压条型分接开关外形、安装尺寸图

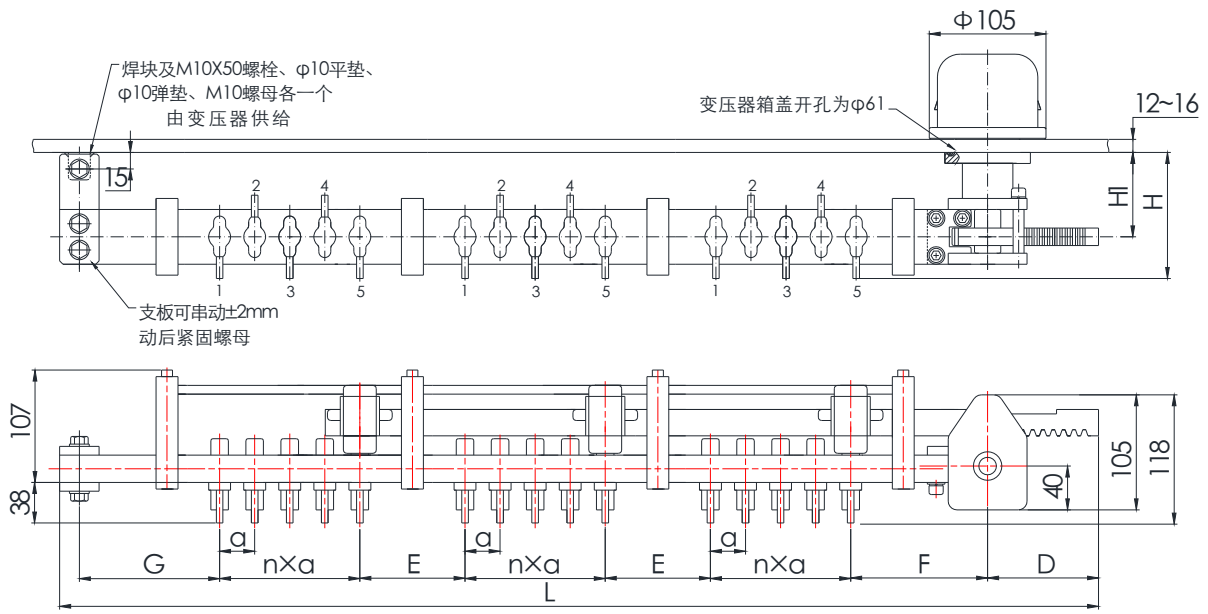

接线片尺寸
Size of connection terminal
2:1

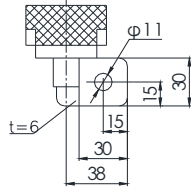

焊块尺寸
Size of welding unit
2:1

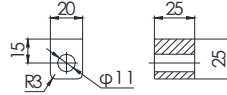

开关型号 Model No.	安装尺寸 (mm) Install Dimension								
	L	D	F	E	a	n	G	H	H1
WSTIII 5 400~500/10-3×3	802	101	156	111	32	2	113	115	78
WSTIII 5 400~500/10-5×5	1059	174	156	111	32	4	113	115	78



图2

欢迎各位用户来我厂定货

Every customer is welcome to come ordering

我公司向用户郑重承诺：质量第一、用户至上，不合格产品绝不出厂。出厂产品出现质量问题包退包换，以质量求生存，以品种求发展。我公司将以一流的服务与广大用户携手共进，密切合作。谢谢！

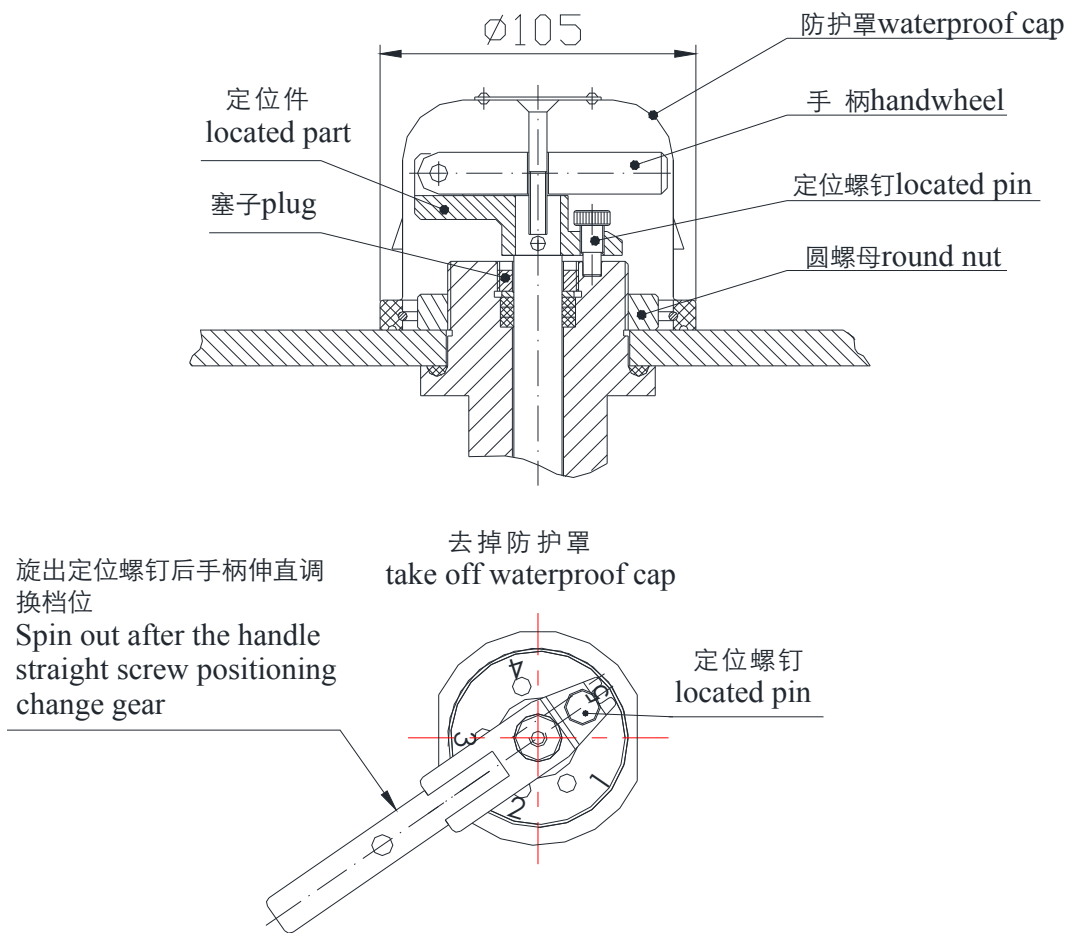
Our company solemnly gives our customers the promise: Quality first, Customer Supreme, No unqualified product is allowed to leave the factory. If there is any problem in quality in the products left the factory, we guarantee to exchange. We seek to live on relying on quality and seek to develop depending on warranty. Our company will advance together with vast customers hand in hand with our first rate service. Thank you!

地址：辽宁省丹东市振安区同兴镇

Add:Tongxing Town Zhen'an District Dandong City Liaoning Province

电话Tel: 0415- 6134555

传真Fax: 0415-6131000